

# ENDOFLATE GI™

## Flexible Endoscope Inflation System



# Table of Contents

Introduction .....	3
System Control Panel.....	3
Safety Precautions .....	4
Intended Use.....	4
Specifications .....	5
Available Scope Inflation Kits .....	6
Installation Procedures.....	6
Programming Menu.....	7
Pressure Regulator .....	9
Connecting Air Line.....	10
Disconnecting Air Line.....	10
Operating EndoFlate .....	11
Troubleshooting .....	12
Replacement Parts.....	12
Wiring Diagram .....	13
Parts Diagram .....	14
EC - Declaration of Conformity.....	15
Warranty .....	16

©2016 Knight LLC. All rights reserved. EndoFlate GI is a trademark of Knight LLC. The trademarks and names of other companies and products are the property of their respective owners.

# Introduction

The Knight EndoFlate GI™ system (EndoFlate) replaces manual leak test inflation devices to provide an automated, hands-free method for pressurizing your scope for a leak test inspection.

EndoFlate is a smart inflation system with advanced microcontroller to precisely pressurize the scope for a wet leak test. EndoFlate provides a easy-to-read digital screen with pressure, timer, bar graph, and date/time. A color-coded screen indicator can notify the endoscopy technician of the liner's failure to pressurize. When this occurs, the EndoFlate pump automatically recharges to maintain positive pressure while the endoscope is attached, preventing fluid ingress during inspection and manual cleaning. EndoFlate's automated inflation system speeds up endoscope reprocessing and supplies accurate and reliable inflation pressure throughout the inspection and manual cleaning process.

## System Control Panel

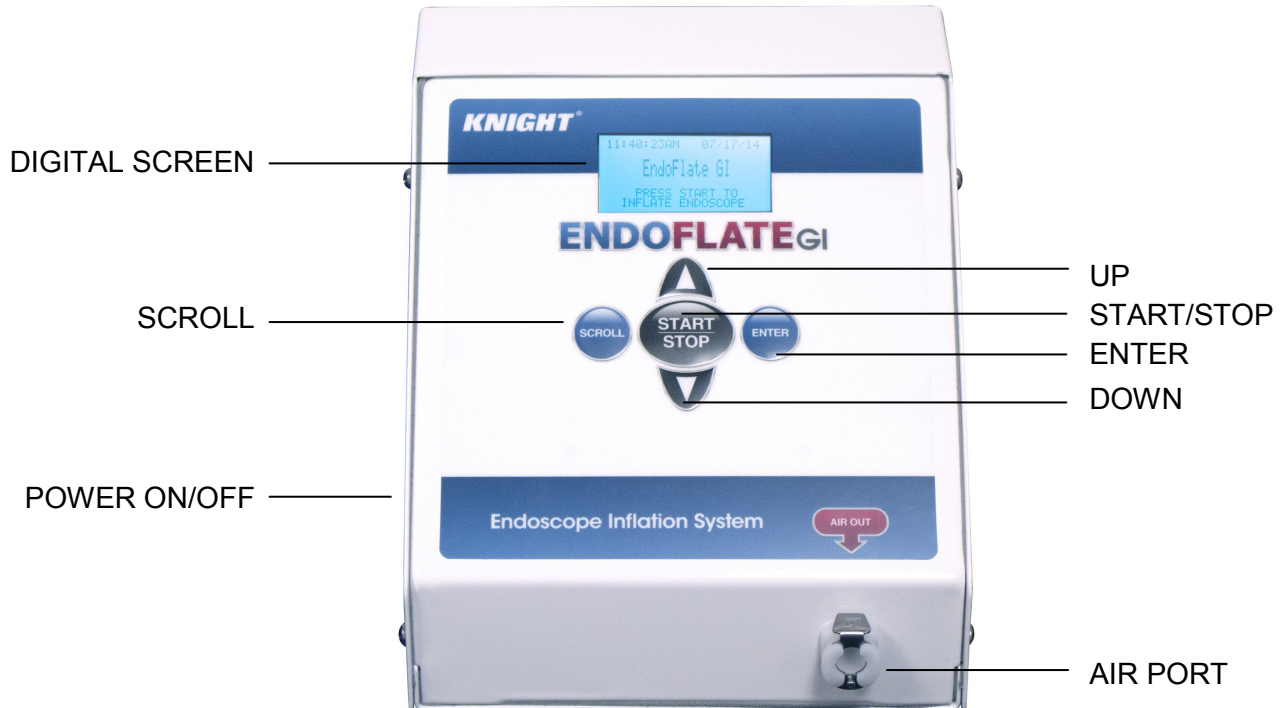

## Indication For Use









The Knight EndoFlate GI™ system (EndoFlate) should be used as an automated inflation system for pressurizing submersible, flexible endoscope in a wet leak test using the water immersion bubble test method performed by an endoscopy technician.

EndoFlate replaces the manual inflation and the analog pressure gauge of a hand-held leak test device. EndoFlate does not directly detect leaks. When using the EndoFlate system, always follow the testing and cleaning procedures defined by the endoscope manufacturer and industry cleaning protocols.

Consult your endoscope manufacturer’s instructions for use to properly test for leaks and reprocess your endoscope.

## Safety symbols





Listed below are explanations of the safety symbols that appear either on the unit, in the instruction manual, or both. Please familiarize yourself with the meaning of each symbol.

	“ON” (power)
	“OFF” (power)
	Class II Equipment
	Operating Instructions
	Follow operating instructions
	Refer to instruction manual/ booklet
	General warning sign
	Caution risk of electric shock or Attention Dangerous Voltage
	This device contains electrical and/or electronic equipment that must be recycled per EU Directive 2012/19/EU – Waste Electrical and Electronic Equipment (WEEE)

## Safety Precautions

- Wear protective clothing and eye protection whenever operating this system.
- Wear protective clothing and eye wear when dispensing chemicals. Observe safe handling instructions (SDS) provided on chemical container or as supplied by chemical manufacturer.
- To avoid severe or fatal shock, physical injury, always disconnect main power when servicing the unit.
- When installing any equipment, ensure that all national and local safety, electrical and plumbing codes are met.
  - System is for indoor use only
  - Do not submerge or place in direct path of spray/moisture
  - System operates with safe 12 Volt DC power
  - Only approved, factory authorized technicians to service unit

## Specifications

Cabinet Materials	#304 stainless steel, powder coated	
Dimensions	6.5" L x 6.25" W x 5.5" H 165mm L x 159m W x 140mm H	
Case Rating	IPXO	
Inflation Pressure	1 psi - 4.5 psi (.068 Bar - .31 Bar )	
Pressure Regulator	Factory set to 4.5 psi (.31 Bar )	
Power Supply/Voltage	Wall mount type, In: 100-240 Volts AC 1A 50-60 Hz Out: 12 volts DC 1.5 A	 
Unit Weight	3.6 lbs 1.62 kgms	
Approvals	CAN/CSA-C22.2 No. 61010-1-04 UL Std. No. 61010-1 (2nd Edition) EN 61010-1:2010	 
Product Testing	CSA International, Irvine, California	

## Available Scope Inflation Kits

A scope inflation kit for your brand of flexible endoscope is sold separately. Please contact our customer service at 1(800) 854-3764 if you do not have an inflation kit.

Item No.	Part Number	Qty.	Description
1	7117161-0	1	Olympus Inflation Kit
2	7117161-P	1	Pentax Inflation Kit
3	7117161-F	1	Fujinon Inflation Kit
4	7117161-S	1	Karl Storz Inflation Kit



## Pre-Installation

EndoFlate can be set on the counter top or shelf. Select a place for the unit within 6ft (1.8m) of a GFI protected power outlet. It is important to keep the power supply cable above the sink level. It is not recommended to use an extension cord. It is important to place the unit on a hard, flat dry surface that is level.

**Before beginning the installation, make sure you have the correct endoscope inflation kit for your brand of scope.**

## Installation

### Power Supply

Route the power supply cable to the power outlet and secure the cables in place. Keep the power supply cable above the sink level.

# Programming Menu

The ENTER key is the main navigation key that will advance the menu from function to function each time it is pressed. The SCROLL key is used to move the cursor. The UP and DOWN arrows are used to change a value. Holding down the UP or DOWN arrow will advance the value faster. Pressing and holding the ENTER key will save any changes and exit you from the programming menu. The screen is blue when the unit is in run mode and purple when it is in the programming mode.

## Accessing the Programming Menu

To access the programming menu, press and hold the ENTER key until the screen changes to a purple screen.

To save changes and exit the programming menu, press and hold the ENTER key until the display changes back to the blue screen. Restart the system after programming is recommended.

PRESS SCROLL TO  
ENTER PASSCODE

0000

**ENDOFLATE GI**

PRESS START TO  
INFLATE ENDOSCOPE

## Passcode Protection

A private passcode protects the system settings and allows only authorized personnel to make programming changes.

To enter a private passcode, press SCROLL, then UP or DOWN to change the value. The default code is: 0000.

PRESS SCROLL TO  
ENTER PASSCODE

0000

## Change Private Access Code

To set or change a private passcode, press SCROLL, then UP or DOWN.

PRESS SCROLL TO  
CHANGE PASSCODE

0000

## Pressure Unit

The pressure unit of the system is available in PSI, bar, and mmHg.

To change the pressure unit, press SCROLL.

PRESS SCROLL TO  
SELECT WHICH  
UNITS TO USE:

[mmHg]

## Information Screen

The system gives you the option to select information to display on the screen when it is in run mode.

Available options are: pressure, timer, bar graph, date/time.

Press UP or DOWN to move the cursor and SCROLL to change the option for YES or NO.

DISPLAY SELECTION:

SHOW PRESSURE: YES  
SHOW TIMER: YES  
SHOW BAR GRAPH: YES  
SHOW DATE/TIME: YES

## Date Format

The date can be displayed as Month-Day-Year or Day-Month-Year. To change the date format, use the Scroll key.

PRESS SCROLL TO  
SELECT WHICH  
DATE FORMAT TO  
USE  
MM-DD-YY

## Date and Time

To set the date and time, press SCROLL and UP or DOWN.

PRESS SCROLL TO  
CHANGE DATE/TIME  
TIME 04:56:46 PM  
DATE 04-07-14

## Inflation Pressure

EndoFlate is set to pressurize your scope to 186 mmHg (3.6 psi). The factory default value is generally accepted. Press the UP or DOWN arrow to change the pressure value. Always follow the endoscope manufacturer's recommended pressure parameters.

PRESS UP/DOWN TO  
ENTER INFLATION  
PRESSURE  
PRESSURE = 187 mmHg

**CAUTION:** If you set the inflation pressure point too low, you may not achieve the required scope pressure to conduct the water immersion test. If you set the pressure point too high, this may damage your endoscope. Follow the endoscope manufacturer's instruction manual for the recommended inflation pressure and procedures to perform a leak test.



## Calibrating EndoFlate Inflation Pump

The EndoFlate GI is factory calibrated. In the event the inflation pump requires field calibration, this menu will allow you to enter the new calibrated pressure.

NOTE: Contact Knight for assistance. You will need a pressure gauge with an air port fitting. **A 10 psi calibrated pressure gauge is recommended.**

1. Connect the air line of the pressure gauge to the air port. See **Connecting the Air Line** on page 10.
2. Press START to begin calibration. Allow the pressure gauge some time to stabilize.
3. Enter the pressure value reading from the pressure gauge into EndoFlate +/- 15% by pressing UP or DOWN.



PRESS START TO TURN AIR PUMP ON. PRESS UP/DOWN TO ENTER PRESSURE VALUE DISPLAYED ON GAUGE. PRESSURE = 186 mmHg

## Pressure Regulator

The maximum inflation pressure of the air pump is controlled by a built-in pressure regulator factory set to 4.5 psi (.31 Bar, 233 mmHg). Should your scope manufacturer specify a different maximum inflation pressure, you can change the pressure regulator value by doing the following:

1. Remove the EndoFlate enclosure.
2. Connect the air line of the pressure gauge to the air port. See **Connecting the Air Line** on page 10.
3. Press START to pressurize the gauge. Allow the pressure gauge some time to stabilize.
4. Locate the pressure regulator knob on the right side of the unit. Turn the regulator knob clockwise to increase regulator pressure, counter clockwise to decrease pressure.

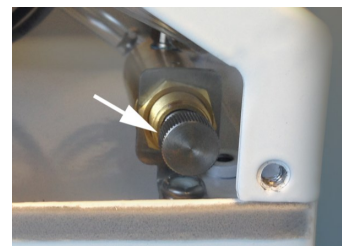

## Connecting the Air Line

Follow the instructions to minimize wear and tear or damage to your connection fittings.

1. Make sure the air port is open for connection.
2. Press down on the metal tab of the air port and it will click open if it was locked. You will not get a click if the air port was already opened.
3. Connect the air line to the air port by pushing the air port connector fitting from the air line into the air port until it snaps into place to form an airtight seal.



## Disconnecting the Air Line

Disconnect the endoscope inflation line daily or as needed for cleaning and disinfection. Consult your chemical supplier for appropriate disinfectants and requirements for proper high-level disinfection (HLD).

1. To remove the air line, press and hold the metal tab of the air port while removing the air line.

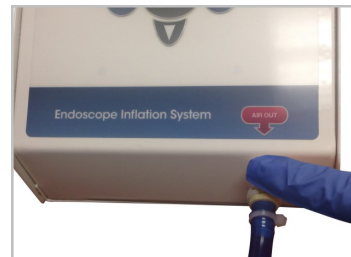

## Operating EndoFlate GI

After you connect the endoscope inflation line to the air port (see **Connecting the Air Line** on page 10), you are ready to pressurize your scope for a leak inspection. Follow the endoscope manufacturer's instructions to properly connect the air line to the endoscope. Consult your endoscope manufacturer's instructions for use to test for leaks and reprocess your scope.

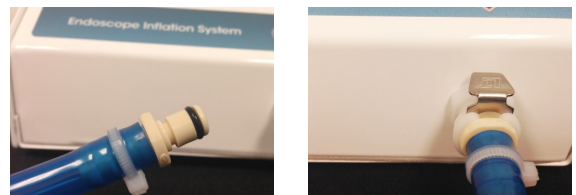

- (1) Fill the container or sink with clean water to the appropriate level as recommended by the endoscope manufacturer or department protocol.

- (2) Connect the scope to EndoFlate by connecting the inflation adaptor to the venting connector.

**CAUTION:** Always ensure the scope connectors and tubing are free from moisture. Follow department protocols for drying the connectors and connector lines.



- (3) Press START to begin pressurizing the scope while the scope is out of the sink. Watch for expansion of rubber covering due to increased internal pressure. With the scope pressurized, manipulate the control knobs in all directions.

If the scope can maintain positive pressure for a minimum of 60 seconds, **continue to step 4** to perform the leak test using the water immersion bubble test method.

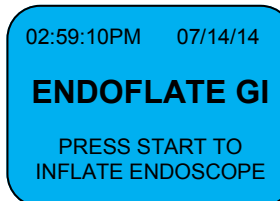

**CAUTION:**

If the scope can't pressurize to the set point within 30 seconds, the screen will turn red. **Do not perform the immersion leak test.** Keep the scope inflated and follow the endoscope manufacturer's instructions for further processing.

The EndoFlate pump will continue to keep the scope pressurized for as long as needed or until the ENTER button is pressed to depressurize the scope.

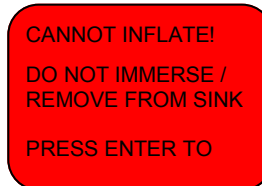
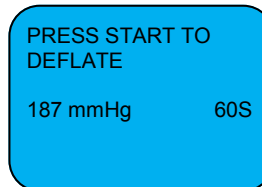

- (4) Submerge the scope in clean water to perform the leak test using the water immersion bubble test method. Angulate the distal tip and observe for a steady stream of bubbles coming from the scope surface.

If no leak is detected by the technician, press the ENTER key to depressurize the scope.



**CAUTION:**

If the technician detects a leak, keep the scope inflated and follow the endoscope manufacturer's instructions for further processing.

**NOTE:** The EndoFlate pump will continue to keep the scope pressurized for as long as needed or until the ENTER key is pressed to depressurize the scope.

## TROUBLESHOOTING

Symptom	Indication	Solutions/Cause
Inflation pump not working	<ul style="list-style-type: none"> <li>No air coming out of the inflation test kit</li> </ul>	<ul style="list-style-type: none"> <li>Inflation hose fitting broken</li> <li>Inflation pump broken</li> </ul>

## REPLACEMENT PARTS

Item No.	Part Number	Qty.	Description
1	0600820	3	Fitting, Elbow, Brass ENP, 10-32 UNF X 1/8 Barb
2	0600821	1	Fitting, Cross, Brass ENP, 1/8 Barb
3	0600774	1	Fitting, PNL MT SKT Non-Valved, 1/8 Flow, 1/8 Barb, Acetal
4	1600322	1	Plug, 1/8 Npt, Nylon
5	7140834	1	C.B. Assy, Endoflate
6	2300326	1	Assy, Solenoid 3-Way 12VDC, Endoflate
7	2300327	1	Assy, Pressure Sensor, Endoflate
8	2000524	1	Power Supply, 12VDC 1.5A 18W 1.5m Cord, w/ Multi AC Plugs
9	7407133	1	Pressure regulator, adjustable 0-20 psi
10	2300328	1	Air Pump, 12VDC

# WIRING DIAGRAM

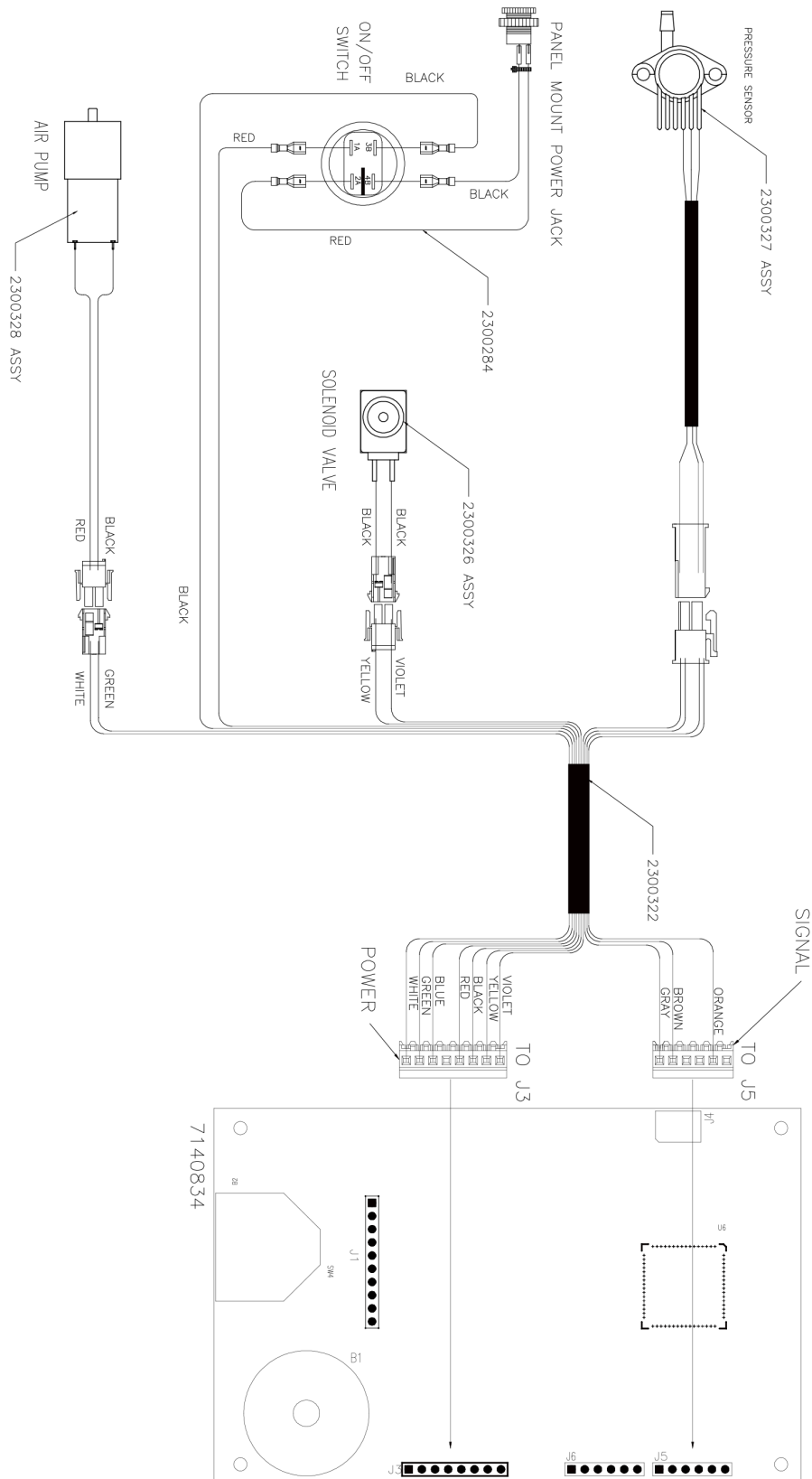

PARTS DIAGRAM

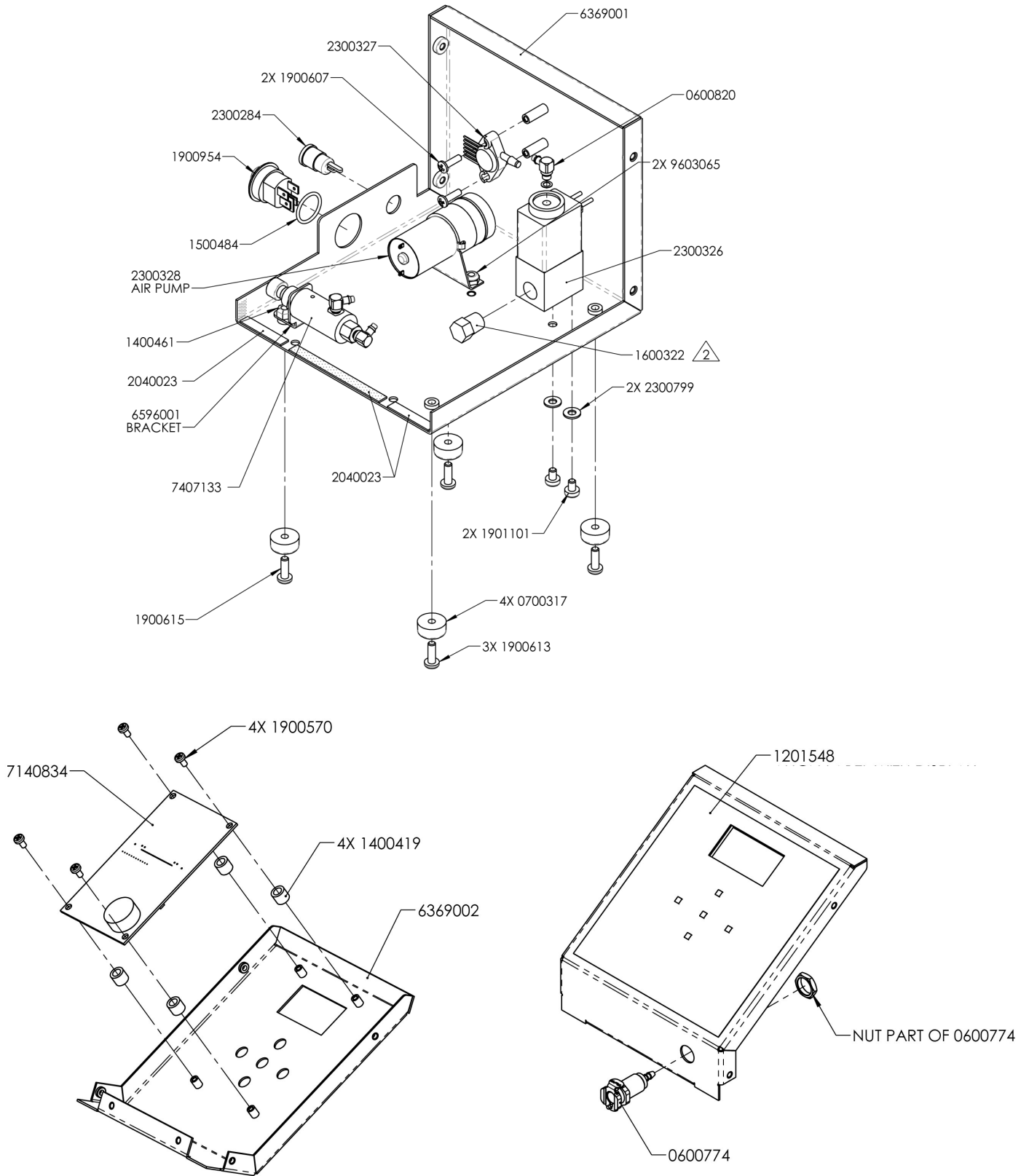

# KNIGHT

## EC – Declaration of Conformity

We declare that the product listed below, to which this Declaration of Conformity relates, is in conformity with the Standards and other Normative Documents listed below:

**Equipment Description:** *Inflation Device for Flexible Endoscopes*  
**Type/Model Number:** *MDCS-06 (EndoFlate GI™)*

**Low Voltage Directive** - 2006/95/EC (and former Directive 73/23/EEC)  
Standards to which Conformity is Declared:

**Electrical Safety** IEC/EN 61010-1:2010 (Third Edition) - Safety Requirements for Electrical Equipment for Measurement, Control, and Laboratory Use, Part 1: General Requirements.

**For Information:** The "Electrical Safety Test" took place at the CSA International, Irvine, CA, U.S.A

### Electromagnetic Compatibility

EMC Directive - 2004/108/EC and former Directive 89/336/EEC as amended by 92/31/EEC and 93/68/EEC  
Standards to which Conformity is Declared:

**EMC Emissions:** CISPR 11: Industrial, scientific and medical (ISM) radio-frequency  
EN 55011: Equipment - Radio disturbance characteristics - Limits and methods of measurement

EN 61000-3-2: Limits for harmonic current emissions  
EN 61000-3-3: Limitation of voltage changes, voltage fluctuations and flicker in public

**EMC Immunity:** EN 61326-1: 2006 Electrical Equipment Measurement, Control & Laboratory Use (Normal Environment)  
EN 61000-4-2: Electrostatic discharge immunity test  
EN 61000-4-3: Radiated, radio-frequency, electromagnetic field immunity test  
EN 61000-4-4: Electrical fast transient/burst immunity test  
EN 61000-4-5: Surge immunity test  
EN 61000-4-6: Immunity to conducted disturbances, induced by radiofrequency fields  
EN 61000-4-11: Voltage dips, short interruptions and voltage variations immunity test

**For Information:** The "Electromagnetic Test" took place at the Aegis Labs., Lake Forest, CA, U.S.A

**Certification Marking:** 

We declared that the equipment specified above conforms to the referenced EU Directives and Harmonized Standards."

Signature:  Date: 06/25/14  
Name: John Chiechi Title: Director of Engineering



## WARRANTY

For complete product terms and conditions scan the QR code below or enter the following URL into your browser:  
<http://cfstech.info/t-and-c>

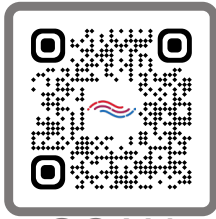

SCAN

## DISCLAIMER

Knight LLC does not accept responsibility for the mishandling, misuse, or non-performance of the described items when used for purposes other than those specified in the instructions. For hazardous materials information consult the label, MSDS, or Knight LLC. Knight products are not for use in potentially explosive environments. Any use of our equipment in such an environment is at the risk of the user. Knight does not accept any liability in such circumstances.

## FOOTNOTE

The information and specifications included in this publication were in effect at the time of approval for publishing. Knight LLC reserves the right to discontinue or change specifications or design at any time without notice and without incurring any obligation whatsoever.



KNIGHT LLC is part of the CFS Technologies family of brands.

[www.knightequip.com](http://www.knightequip.com) | [cfstech.com](http://cfstech.com)

8504 MacArthur Dr., North Little Rock, AR 72118 USA • 501-895-2820 | 800-999-2820

General: [sales@cfstech.com](mailto:sales@cfstech.com) | Tech. Assist.: [techsupport@cfstech.com](mailto:techsupport@cfstech.com)