

Uniflow 1/2" Bolted Plastic Pumps Operating Instructions

KNIGHT

UNIFLOW

Model	Part	Description
KAP-50SK	1600979	PVDF/Santoprene
KAP-50SP	1600968	Poly/Santoprene
KAP-50TP	1600945	Poly/TF
KAP-50TK	1600986	PVDF/TF

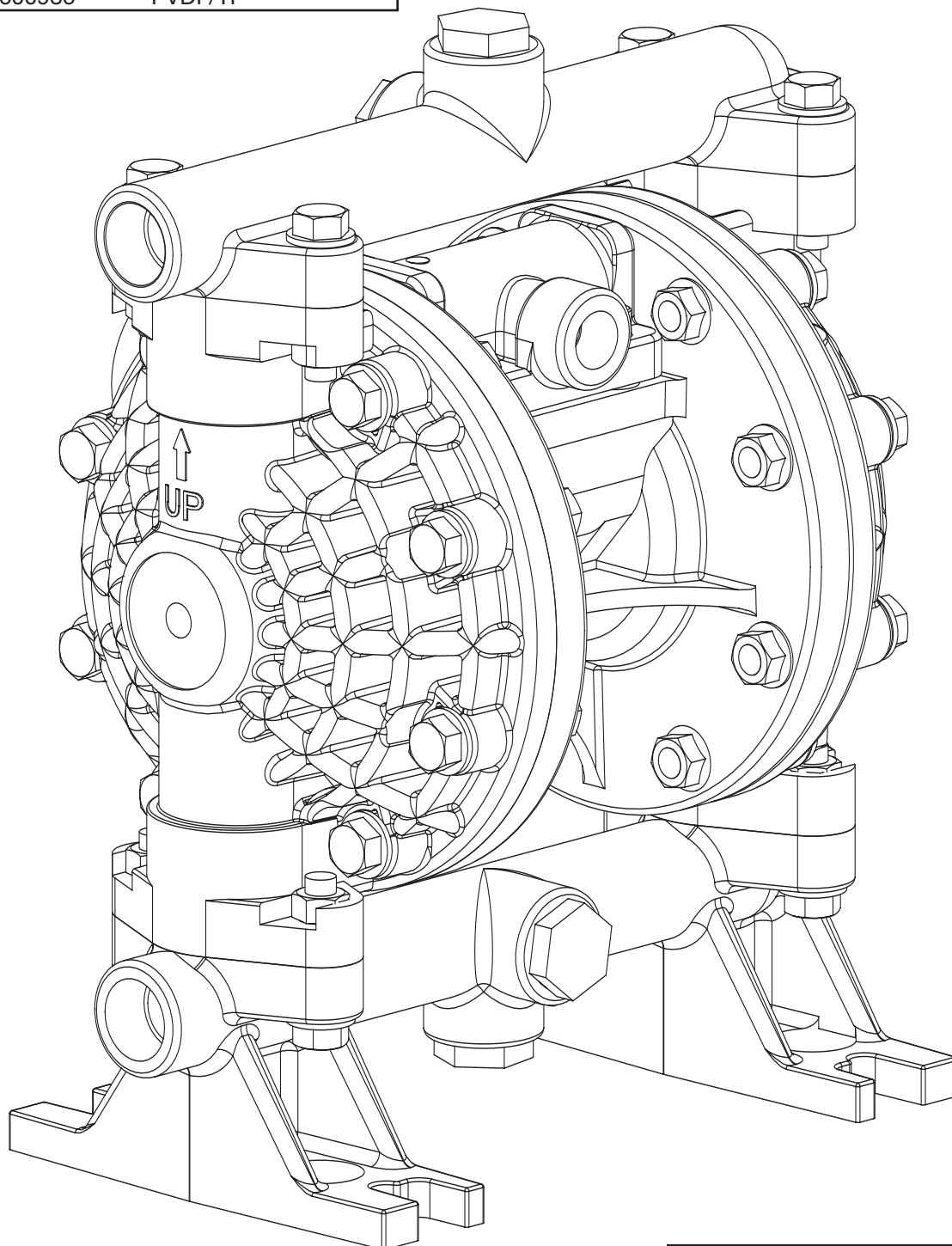

IDEX
IDEX CORPORATION

SAFETY WARNINGS

Read these instructions completely before installation and start-up. It is the responsibility of the purchaser to retain this manual for reference. Failure to comply with the recommendations stated in this manual could result in death, serious bodily injury and/or property damage including damage to the pump and/or voiding the factory warranty.

Correct pump selection is crucial to the pump operation. Please assure pressure, temperature and chemical compatibility before installation. Please consult Knight Equipment, Engineering Specifications, Chemical Compatibility Chart, or your distributor if in doubt about any application.

Operating Limitations for Various Elastomers

Neoprene	0°F (-18°C) to 200°F (93°C)
Buna-N	10°F (-12°C) to 180°F (82°C)
Nordel	-60°F (-51°C) to 280°F (138°C)
Viton	-40°F (-40°C) to 350°F (176°C)
PTFE	40°F (4°C) to 220°F (105°C)
Polyurethane	10°F (-12°C) to 170°F (77°C)
XL TPE (Santoprene)	-20°F (-29°C) to 300°F (149°C)
FDA Hytrel	-20°F (-29°C) to 220°F (104°C)

Operating Limitations for Plastic Pumps

Kynar (PVDF)	10°F (-12°C) to 225°F (107°C)
Polypropylene	32°F (0°C) to 175°F (79°C)

Maximum temperature limits are based upon mechanical stress only. Certain chemicals and environment conditions significantly reduce maximum safe temperature limits.

Before pump operation, inspect all gasketed fasteners for looseness caused by gasket creep. Re-torque all loose fasteners to prevent leakage. Follow recommended torques

stated in this manual. Failure of the sealing components creates the possibility of jetting or forceful discharge of pumped material at a potentially harmful velocity.

Be certain that approved eye protection and protective clothing are always worn during installation, service, maintenance or when in the vicinity of the pump. Failure to follow these recommendations may result in serious injury or death.

Never allow the piping system to be supported by the pump manifolds or valve housing. The manifolds and valve housing are not designed to support any structural weight and failure of the pump may result.

Take action to prevent static sparking. Fire or explosion can result, especially when handling flammable liquids. The pump, piping, valves, containers, or other miscellaneous equipment must be grounded.

Noise levels can exceed 85 dBA. Take precautions to prevent personal injury due to excessive pump noise.

Do not exceed pump maximum operating pressure (found on label and/or operating manual.)

Before doing any maintenance or repair on this pump, be certain all pressure is completely vented for the pump, suction, discharge, piping, and all other openings.

In the event of a diaphragm rupture, pumped material may enter the air end of the pump and be discharged into the atmosphere. If pumping a product that is hazardous or toxic, the air exhaust must be piped to an appropriate area for safe disposition.

INSTALLATION, OPERATION AND MAINTENANCE

Installation

The pump should be mounted in a vertical position. In permanent installations, the pump should be attached to plant piping using a flexible coupling on both the intake and discharge connections to reduce vibration to the pump and piping. To further reduce vibration, a surge suppressor next to the pump may be used.

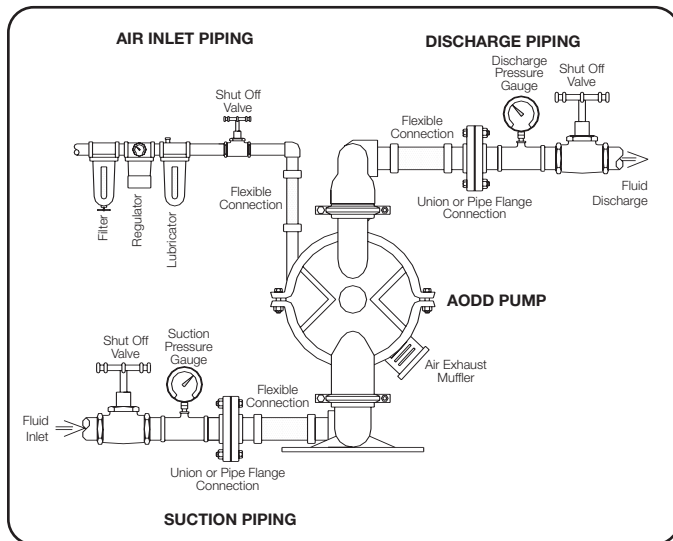

Suction pipe size should be at least the same diameter as the inlet connection size, even larger if highly viscous fluid is to be pumped. If suction hose is used, it must be of a non-collapsible reinforced type. Discharge piping should be of at least the same diameter as the discharge connection. It is critical,

especially on the suction side of the pump, that all fittings and connections are air tight or pumping efficiency will be reduced and priming will be difficult.

Make certain the air supply line and connections and compressor are capable of supplying the required pressure and volume of air to operate the pump at the desired flow rate. The quality of the compressed air source should be considered. Air that is contaminated with moisture and dirt may result in erratic pump performance and increased maintenance cost as well as frequent process “down time” when the pump fails to operate properly.

Pump Operation

The pump is powered by compressed air. Compressed air is directed to the pump air chamber by the main air valve. The compressed air is separated from the fluid by a membrane called a diaphragm. The diaphragm in turn applies pressure on the fluid and forces it out of the pump discharge. While this is occurring, the opposite air chamber is de-pressurized and exhausted to atmosphere and fluid is drawn into the pump suction. The cycle again repeats, thus creating a constant reciprocating action which maintains flow through the pump. The flow is always in through the bottom suction connection and out through the top discharge connection. Since the air pressure acts directly on the diaphragms, the pressure applied to the fluid roughly approximates the air supply pressure supplied to the main air valve.

Recommended Piping Connections

Pump Size	Minimum Air Line Size	Minimum Suction Line Size
1/2"	1/2"	1/2"

Torque Settings

Manifold Bolts	35 in-lbs (4.0 N-m)
Water Chamber Bolts	60 in-lbs (6.8 N-m)
Diaphragm Plates — Rubber	75 in-lbs (8.5 N-m)
Diaphragm Plates ---PTFE	60-lbs (6.8 N-m)
Air Valve Cap Screws	30 in-lbs (3.4 N-m)

TYPICAL INSTALLATIONS

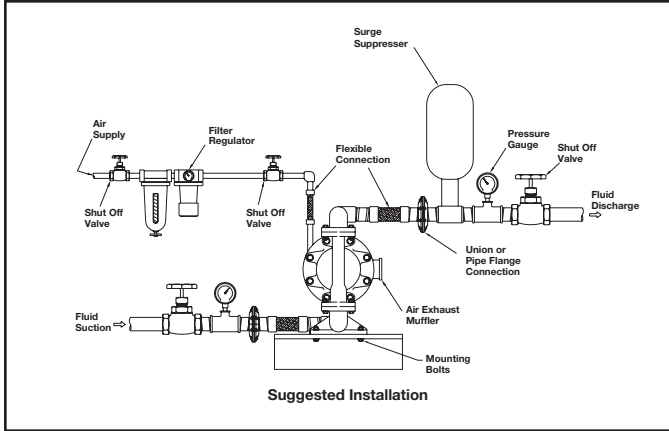

Suggested Installation

A **typical installation** showing all the components that are recommended in a system, including valves, pressure gauges, air regulators, filters, and surge suppressors.

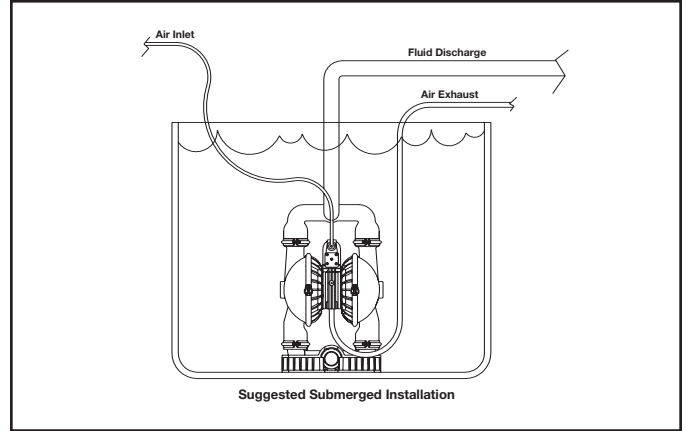

Suggested Submerged Installation

In a **submerged application**, the air exhaust port of the pump must be ported above the fluid line. Be certain that the fluid being pumped is compatible with the materials on both the airside and the wetted side of the pump before the pump is submerged.

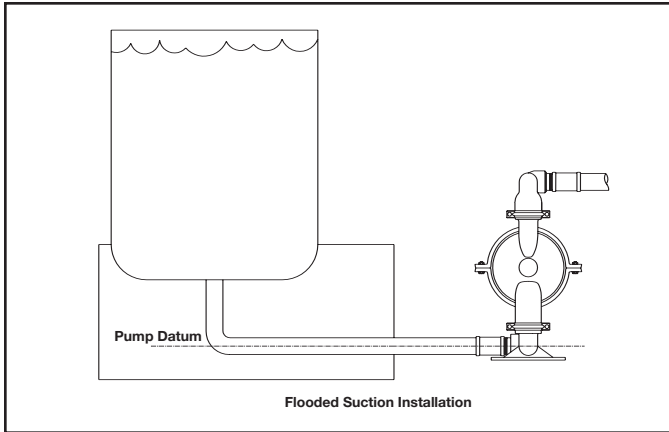

Flooded Suction Installation

A **flooded suction installation** has the pump datum line below the fluid level. **IMPORTANT:** in flooded suction installations the pressure at the fluid inlet of the pump should never exceed 69 kPa (10 psi).

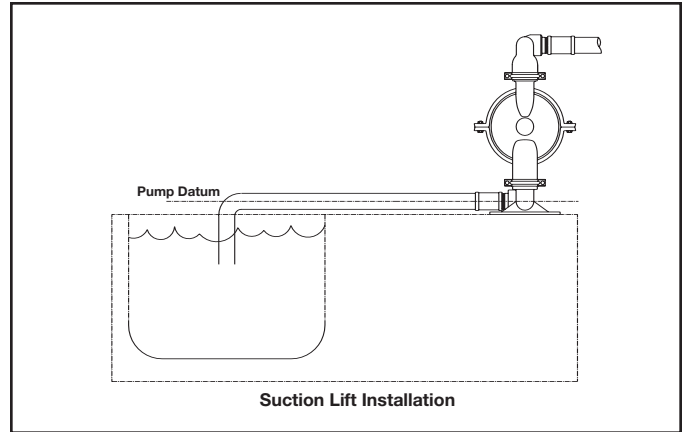

Suction Lift Installation

In **suction lift installations** the pump datum is above the fluid line. **IMPORTANT:** each pump has different lift capabilities. Be sure to verify the lift capability of a particular pump before installing it into a system.

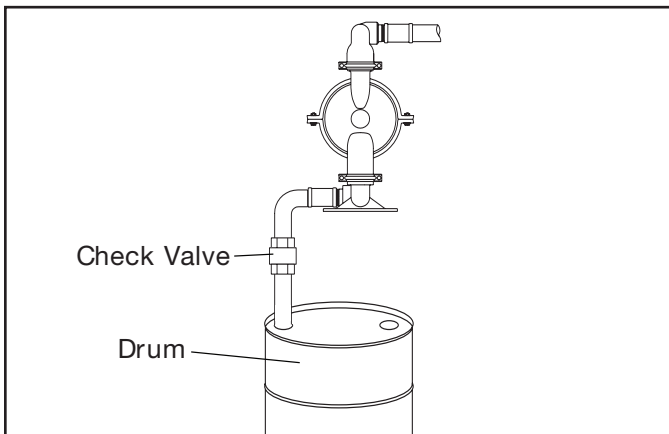

To maintain prime use a **suction check valve** inserted in suction tube/pipe.

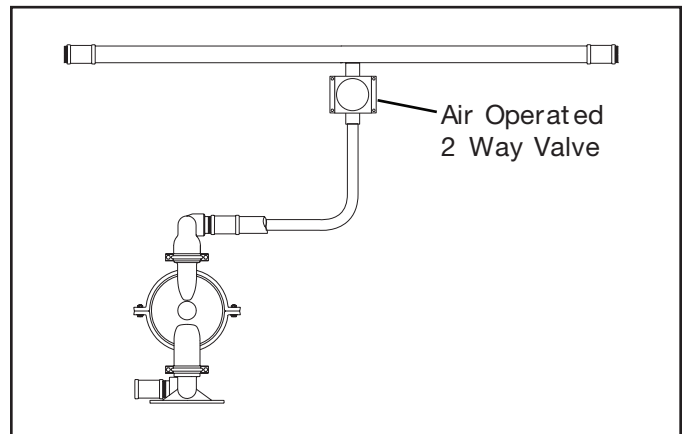

Use of an air operated **anti-siphon check valve** for closed system installations such as pressurized pipe is recommended.

PARTS LIST

AIR VALVE ASSEMBLY

Item	Description	Quantity
	Air Valve Assembly (Includes items 1-10)	
1	Valve Body	1
2	Valve Spool	1
3	Valve Spool U-Cup	2
4	End Cap	2
5	End Cap O-Ring	2
6	Staple	2
7	Air Diverter	1
8	Valve Insert	1
9	Valve Gasket	1
10	Valve Screw	4

AIR END ASSEMBLY

Item	Description	Quantity
11	Center Section	1
18	Pilot Shaft	1
19	Pilot Shaft Spacer	5
20	Pilot Shaft O-Ring	6
21	Pilot Shaft Snap Ring	2
22	Shaft Retainer	2
25	Shaft Retainer Screw	4
33	Muffler	1

DIAPHRAGM ASSEMBLY

Item	Description	Quantity
34	Main Shaft O-Ring	2
35	Main Shaft	1
37	Inner Diaphragm Plate	2
38	Outer Diaphragm Plate	2
40	Diaphragm	2
41	Back-Up Diaphragm	2

WET END ASSEMBLY

Item	Description	Quantity
44	Water Chamber	2
45	Water Chamber Bolt	16
46	Water Chamber Washer	16
47	Water Chamber Nut	16
48	Valve Ball Cage	4
49	Valve Seat O-ring	4
50	Valve Seat	4
52	Valve Ball	4
53	Discharge Manifold	1
54	Inlet Manifold	1
55	Manifold Plugs	4
63	Manifold Bolts	8
64	Manifold Washers	8
65	Manifold Nuts	8

Teflon® is a registered trademarks of DuPont. Kynar® is a registered trademark of Penwalt Corp. Geolast® is a registered trademark of AES.



20531 Crescent Bay Drive
Lake Forest, CA 92630
(949) 595-4800 • (800) 854-3764
Fax: (949) 595-4801
www.knightequip.com

Distributed by: